

Itap Kogelkraan messing vernikkeld 3/4" binnendraad 40bar type 090 (0402314)



TECHNISCHE SPECIFICATIES

Type	090
Materiaal	messing
Oppervlaktebehandeling	vernikkeld
Bediening	hendel
Kleur hendel	rood
Materiaal hendel	staal
Materiaal kogel	messing hard verchroomd
Materiaal huis	messing
Materiaal afdichting	PTFE
Verbinding	binnendraad
Max. temperatuur	150 °C
Min. mediumtemperatuur (continu)	-20 °C
Doorlaat	full
Maat	3/4"
Werkdruk	40 bar

AFMETINGEN

Ct-1 55 mm

F-1 13.5 mm

F-2 12.5 mm

Lb 57,5 mm

R 113 mm

ØDf 20 mm

ØDi-1 3/4 "

ØDi-2 3/4 "

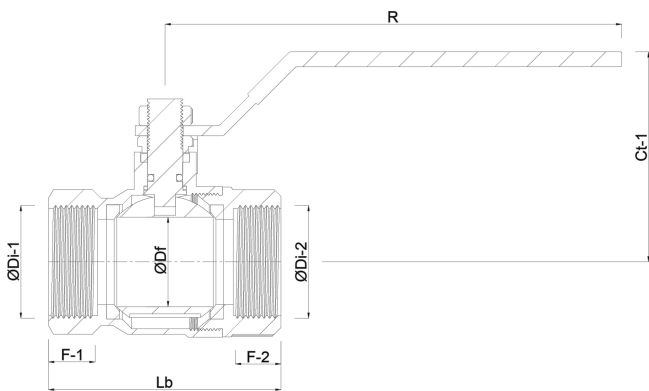

Gegeneerd op datum: 21-02-2026

<http://www.bosta.com>