

**VIR Kogelkraan messing  
verchromd 1/4" binnendraad  
40bar WRAS/VA type 340B  
(0400969)**



# TECHNISCHE SPECIFICATIES

Type	340B
Materiaal	messing
Oppervlaktebehandeling	verchroomd
Keurmerk	WRAS/VA
Bediening	hendel
Kleur hendel	blauw
Materiaal hendel	dacromet staal
Constructie huis	2-delig
Materiaal kogel	messing hard verchroomd
Materiaal huis	messing
Materiaal afdichting	PTFE
Verbinding	binnendraad
Doorlaat	full
Temperatuurbereik	0°C - 150°C
Maat	1/4"
Werkdruk	40 bar

# AFMETINGEN

Ct-1 41 mm

F-1 9 mm

F-2 9 mm

Hoogte handgreep 41

Lb 39 mm

R 81 mm

ØDf 10 mm

ØDi-1 1/4 "

ØDi-2 1/4 "

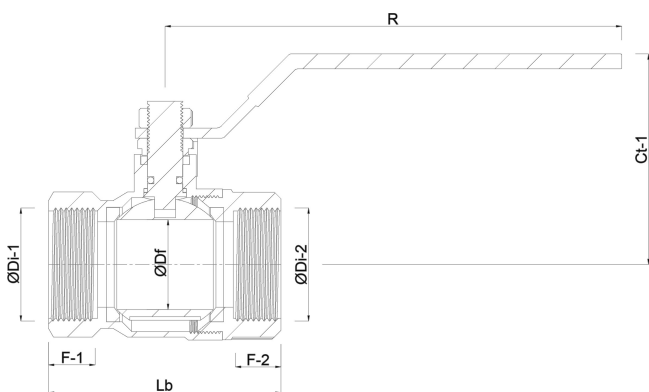

**Gegeneerd op datum: 21-02-2026**

<http://www.bosta.com>