

**VDL Verloopring PVC-U 280
mm x 200 mm lijmspie x
lijmmof 10bar grijs (7018141)**



VL Van de Lande

TECHNISCHE SPECIFICATIES

Kleur	grijs
Materiaal	PVC-U
Maat	280 mm x 200 mm
Verbinding	lijmspie x lijmmof
Werkdruk	10 bar

AFMETINGEN

L	146 mm
P-1	106 mm
ØDi-2	200 mm
ØDo-1	280 mm

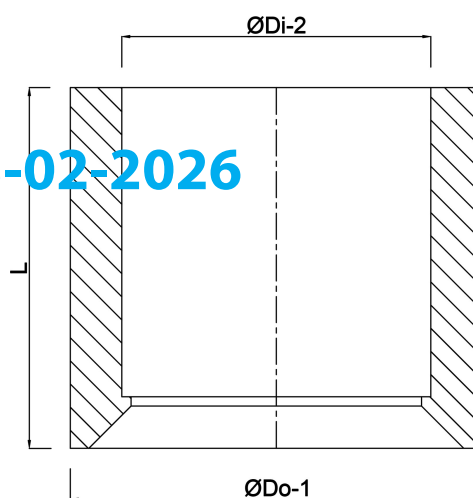

Gegenererd op datum: 23-02-2026

<http://www.bosta.com>