

**VDL Verloopring PVC-U 250
mm x 160 mm lijmspie x
lijmmof 10bar grijs (7002699)**



VL Van de Lande

TECHNISCHE SPECIFICATIES

Kleur	grijs
Materiaal	PVC-U
Maat	250 mm x 160 mm
Verbinding	lijmspie x lijmmof
Werkdruk	10 bar

AFMETINGEN

L	131 mm
P-1	86 mm
ØDi-2	160 mm
ØDo-1	250 mm

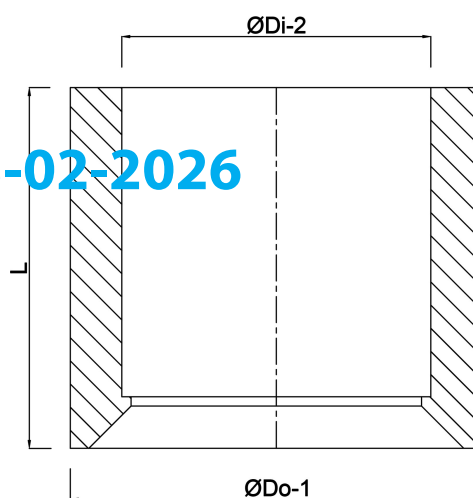

Gegenerereerd op datum: 23-02-2026

<http://www.bosta.com>