

Profec Nr. 121 Knie 45° RVS 316
3/4" binnendraad x
buitendraad 10bar (0081243)



TECHNISCHE SPECIFICATIES

Materiaal	RVS 316
Verbinding	binnendraad x buitendraad
Fitting nr.	Nr. 121
Werkdruk	10 bar
Maat	3/4"

AFMETINGEN

Cb-1	23 mm
Cb-2	37 mm
ØDi-1	3/4 "
ØDo-2	3/4 "
β	45 °

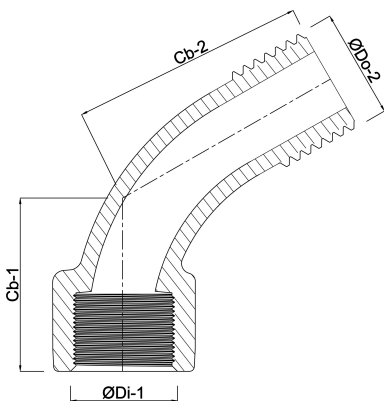

Gegenerereerd op datum: 20-02-2026

<http://www.bosta.com>