

VDL Verloopring PVC-U 225 mm x 125 mm lijmspie x lijmmof 10bar grijs (7002692)



VL Van de Lande

TECHNISCHE SPECIFICATIES

Kleur	grijs
Materiaal	PVC-U
Maat	225 mm x 125 mm
Verbinding	lijmspie x lijmmof
Werkdruk	10 bar

AFMETINGEN

L	119 mm
P-1	69 mm
ØDi-2	125 mm
ØDo-1	225 mm

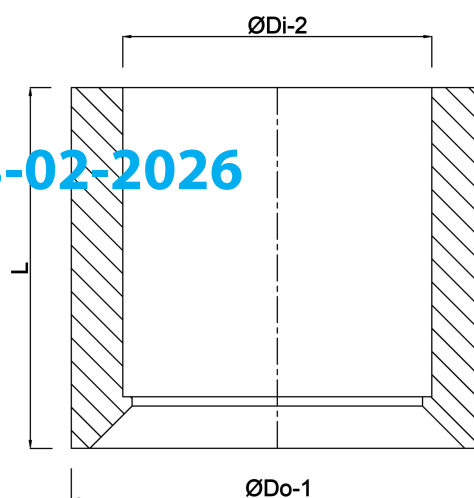

Gegenerereerd op datum: 23-02-2026

<http://www.bosta.com>