

**Profec Blind flange PVC-U
DN20 x 25 mm DIN flange
16bar DN20 grey PN10/16
(0111020)**



TECHNICAL SPECIFICATIONS

Colour	grey
Material	PVC-U
Connection	DIN flange
Size	DN20 x 25 mm
Bolt	M12
Packaging	150 pcs
DN	20
Flange	PN10/16
Outer ø	105 mm
Weight	0.106 kg
Length bolt	60 mm
Thickness	12 mm
Pressure	16 bar
Bolt hole	14 mm
Holes	4

DIMENSIONS

O 14 mm

PCD 76 mm

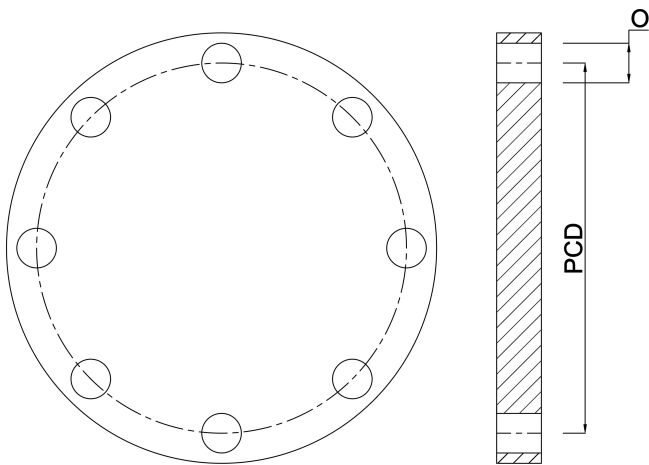

PRODUCT INFORMATION

For PCD, bolt hole size and number see Technical specifications "How to identify a flange" at the back of the catalogue (PCD equals K)

Last modified date: 20/02/2026

Bosta UK Ltd.
Reflection House
Olding Road
Bury St. Edmunds
Suffolk
IP33 3TA
T +44 (0) 1284 716580
E enquiries@bosta.co.uk
<http://www.bosta.com>