

**Profec Flange adaptor PVC-U
DN25 x 32 mm DIN flange x
glue socket 10bar DN25 grey
PN10 (0111082)**



TECHNICAL SPECIFICATIONS

Colour	grey
Material	PVC-U
Connection	DIN flange x glue socket
Size	DN25 x 32 mm
Bolt	M12
DN	25
Flange	PN10
Outer ø	115 mm
Weight	0.137 kg
Length bolt	60 mm
Thickness	14 mm
Pressure	10 bar
Bolt hole	14 mm
Holes	4

DIMENSIONS

O	14 mm
---	-------

PCD 85 mm

ØDi-1 32 mm

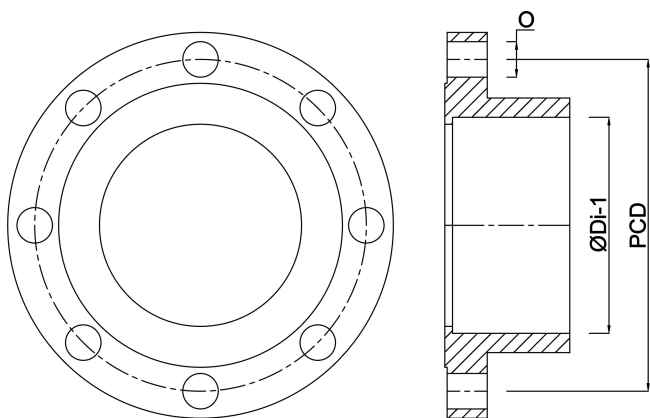

Last modified date: 20/02/2026

Bosta UK Ltd.
Reflection House
Olding Road
Bury St. Edmunds
Suffolk
IP33 3TA
T +44 (0) 1284 716580
E enquiries@bosta.co.uk
<http://www.bosta.com>