

**Profec Flange adaptor PVC-U
DN80 x 90 mm DIN flange x
glue socket 16bar DN80 grey
PN10/16 (0111047)**



TECHNICAL SPECIFICATIONS

Colour	grey
Material	PVC-U
Connection	DIN flange x glue socket
Size	DN80 x 90 mm
Bolt	M16
DN	80
Flange	PN10/16
Outer ø	200 mm
Weight	0.78 kg
Length bolt	90 mm
Thickness	20 mm
Pressure	16 bar
Bolt hole	18 mm
Holes	8

DIMENSIONS

O	18 mm
---	-------

PCD 160 mm

ØDi-1 90 mm

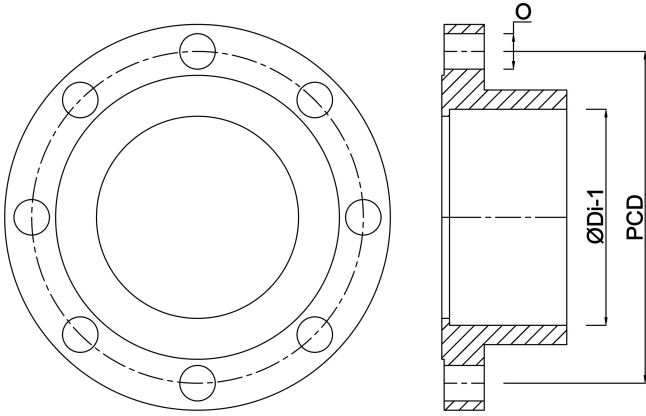

Last modified date: 20/02/2026

Bosta UK Ltd.
Reflection House
Olding Road
Bury St. Edmunds
Suffolk
IP33 3TA
T +44 (0) 1284 716580
E enquiries@bosta.co.uk
<http://www.bosta.com>