

**3-way ball valve L-bore brass
nickel plated 3/4" female
thread 16bar DN20 type L-bore
side connection (0401477)**



TECHNICAL SPECIFICATIONS

Type L-bore

Material brass

Surface treatment nickel plated

Operation lever

Colour lever red

Handle material aluminium

Ball material hard chrome plated brass

Shaft PVC

Material housing brass

Material seal PTFE

Ball bore L-bore

Connection type side connection

Connection female thread

Flow full

Temperature range -30°C - 150°C

Pressure 16 bar

Size 3/4"

DN

20

DIMENSIONS

Ct-1 83 mm

F-1 22 mm

F-2 22 mm

Lb 92 mm

R 145 mm

ØDf 20 mm

ØDi-1 3/4 "

ØDi-2 3/4 "

ØDi-3 3/4 "

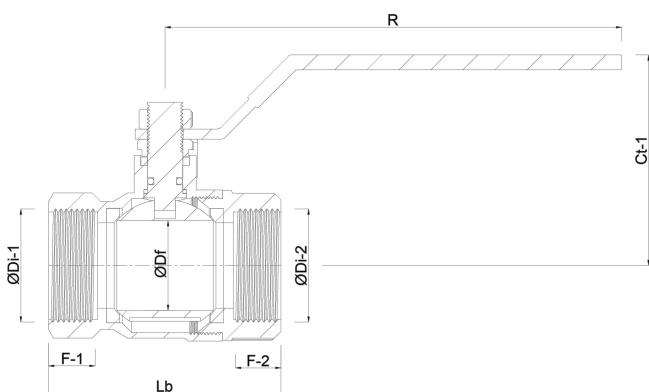

Last modified date: 21/02/2026

Bosta UK Ltd.
Reflection House
Olding Road
Bury St. Edmunds
Suffolk
IP33 3TA
T +44 (0) 1284 716580
E enquiries@bosta.co.uk
<http://www.bosta.com>