

VDL Ball valve PVC-U 32 mm glue socket 16bar grey type DIL viton (7018379)



VDL Van de Lande

TECHNICAL SPECIFICATIONS

Colour grey

Type DIL viton

Material PVC-U

Operation lever

Colour lever green

Handle material PVC-U

Housing construction 3-part

Material seal viton

Connection glue socket

Temperature range 0°C - 60°C

Size 32 mm

Pressure 16 bar

DIMENSIONS

Ct-1 66 mm

Lb 108 mm

R 94 mm

ØDf 25 mm

ØDi-1 32 mm

ØDi-2 32 mm

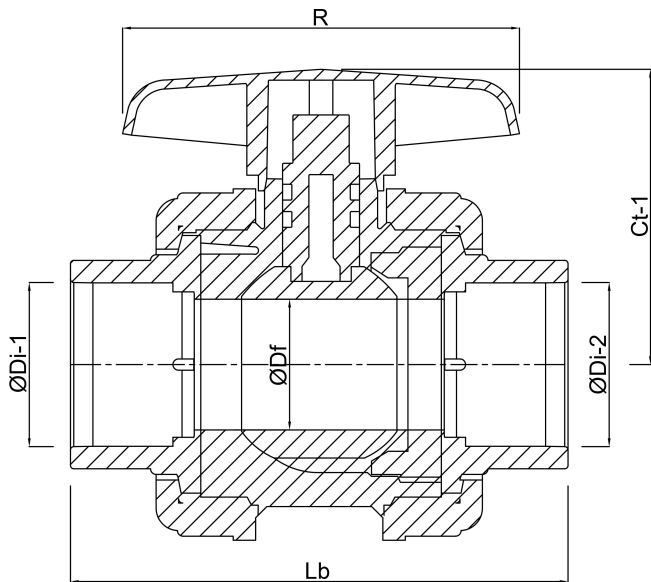

Last modified date: 23/02/2026

Bosta UK Ltd.
Reflection House
Olding Road
Bury St. Edmunds
Suffolk
IP33 3TA
T +44 (0) 1284 716580
E enquiries@bosta.co.uk
<http://www.bosta.com>