

**VIR Ball valve brass chrome
plated 1 1/2" female thread
40bar WRAS/VA type 340B
(0400975)**



TECHNICAL SPECIFICATIONS

Type	340B
Material	brass
Surface treatment	chrome plated
Approval	WRAS/VA
Operation	lever
Colour lever	blue
Handle material	dacromet steel
Housing construction	2-part
Ball material	hard chrome plated brass
Material housing	brass
Material seal	PTFE
Connection	female thread
Flow	full
Temperature range	0°C - 150°C
Size	1 1/2"
Pressure	40 bar

DIMENSIONS

Ct-1 79 mm

F-1 17 mm

F-2 17 mm

Handle height 79

Lb 94 mm

R 141.5 mm

ØDf 40 mm

ØDi-1 1 1/2 "

ØDi-2 1 1/2 "

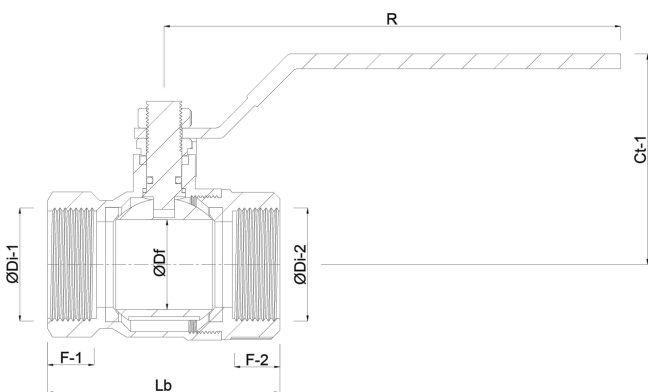

Last modified date: 21/02/2026

Bosta UK Ltd.
Reflection House

Olding Road
Bury St. Edmunds
Suffolk
IP33 3TA
T +44 (0) 1284 716580
E enquiries@bosta.co.uk
<http://www.bosta.com>