

Flotide Sand filter
PE/fibreglass-reinforced
polyester 50 mm / 1 1/2"
metric/imperial glue socket
2,5bar grey type V400
(0891900)



FLOTIDE



bosta
bringing water to life

TECHNICAL SPECIFICATIONS

Colour	grey
Material	PE/fibreglass-reinforced polyester
Connection	metric/imperial glue socket
Pressure	2,5 bar
Max. temp.	43 °C
Type	V400
Capacity	6 m ³ /h
Size	50 mm / 1 1/2"
Diameter	400 mm
Weight	12.9 kg
Sand	35 kg
Filter area	0.13 m ²
Max flow rate	6 m ³ /h
Max. pool vol.	30 m ³

DIMENSIONS

A	757 mm
---	--------

B	21 "
B	21 " inch
B	410 mm
C	640 mm
D	580 mm

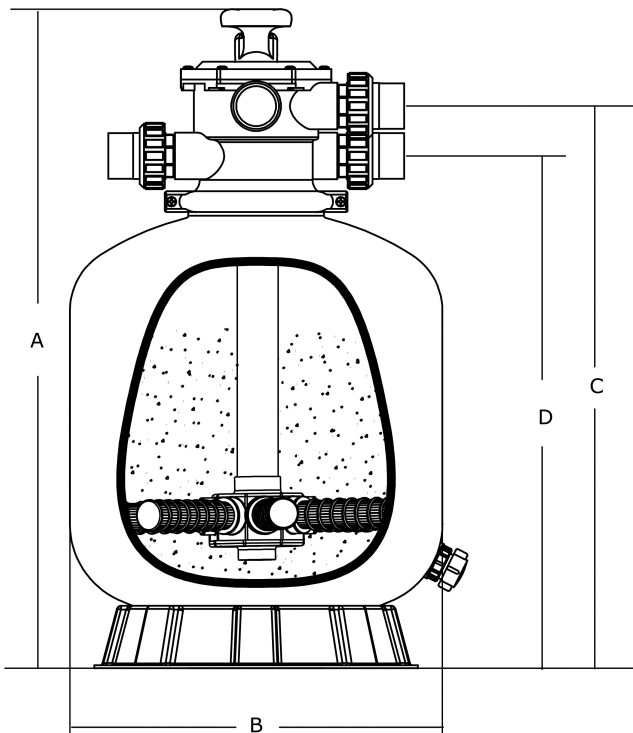

PRODUCT INFORMATION

PE lined fibreglass reinforced polyester tank with unequalled strength and durability equipped with top-mount 6-way valve.

- Made of fibreglass and polyester (DSM resin). Internal PE lining
- Clamp lock is designed to allow 360 degree rotation to simplify installation
- Top diffuser ensures even distribution of water over the top of the sand bed

- Large sand/water drain for rapid winterising or servicing
- The non-corrosive materials are suitable for all-weather performance
- Easy-to-use multi-port valve lets you select any of the operations with a simple lever action
- UV resistant surface allows the filter to work under direct sunlight
- Warranty period: 2 years

Last modified date: 22/02/2026

Bosta UK Ltd.
Reflection House
Olding Road
Bury St. Edmunds
Suffolk
IP33 3TA
T +44 (0) 1284 716580
E enquiries@bosta.co.uk
<http://www.bosta.com>