

Profec Ball valve PVC-U 2" imperial glue socket 10bar grey type 2001 (0112066)



TECHNICAL SPECIFICATIONS

Colour grey

Type 2001

Material PVC-U

Operation lever

Colour lever red

Handle material PVC-U

Housing construction 3-part

Ball material PVC-U

Material housing PVC-U

Material seal PE/EPDM

Connection imperial glue socket

Temperature range 0°C - 60°C

Size 2"

Pressure 10 bar

DIMENSIONS

Ct-1 120 mm

Lb 198 mm

R 109 mm

ØDf 60 mm

ØDi-1 2 "

ØDi-2 2 "

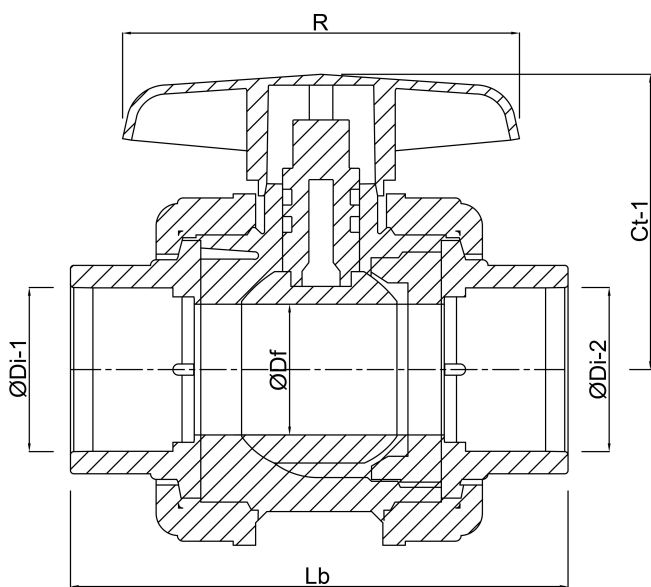

Last modified date: 20/02/2026

Bosta UK Ltd.
Reflection House
Olding Road
Bury St. Edmunds
Suffolk
IP33 3TA
T +44 (0) 1284 716580
E enquiries@bosta.co.uk
<http://www.bosta.com>