

**Grundfos Variable speed
circulation pump cast iron
DN40 flange 10bar 0.72A
230VAC black/red type
MAGNA1 40-40F EuP ready
(7039223)**



GRUNDFOS 

TECHNICAL SPECIFICATIONS

Colour black/red

Material cast iron

Pump body cast iron

Material impeller 1 fibreglass-reinforced PES

Connection flange

Voltage 230VAC

Max. temperature 110 °C

Minimum medium temperature -15 °C
(continuous)

Impellers 1

Frequency 50 Hz

Maximum ambient temperature 40 °C

Pressure 10 bar

Minimum ambient temperature 0 °C

Type MAGNA1 40-40F EuP ready

Max. head 4 m

Size DN40

Ampere

0.72 A

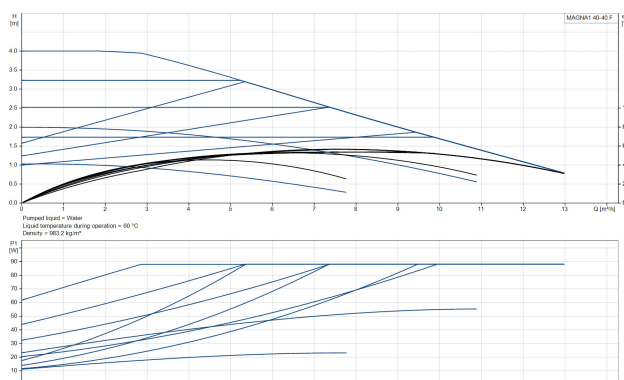
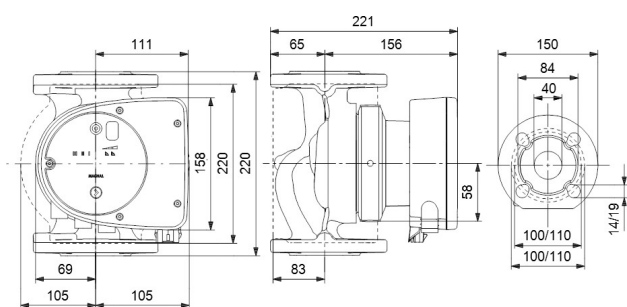

PRODUCT INFORMATION

The new MAGNA1 is the simple option for a job well done. It is the perfect choice when replacing older circulators and due to its compliance with the EuP 2015 regulations, substantial savings on electricity is a reality. The ideal choice for basic performance needs in applications where basic system control and monitoring is desired. Monitoring via the fault relay, ensuring peace of mind. Digital start/stop input available for remote pump control. Continuous operation and reduced downtime with the wireless twin pump function(available on twin-head pumps) High energy efficiency resulting in substantial savings on electricity. Easy setup and operation via the simple user interface. No maintenance due to the canned-rotor type design. MAGNA1 is the simple and efficient choice for most applications including heating, main pump, mixing loops, heating surfaces, cooling, air conditioning surfaces, ground source heat pump systems and smaller chiller applications.

Features:

- Proportional-pressure control.
- Constant-pressure control.
- Constant-curve/constant-speed duty.
- No external motor protection required.
- Insulating shells supplied with single-head pumps for heating systems.
- Wide temperature range due to thermal separation of the control box and pumped media.

Last modified date: 12/06/2026

Bosta UK Ltd.
Reflection House
Olding Road
Bury St. Edmunds
Suffolk
IP33 3TA
T +44 (0) 1284 716580
E enquiries@bosta.co.uk
<http://www.bosta.com>