

**Profec Gate valve cast iron GG
25 powder coated DN50 DIN
flange 10bar DN50 black
PN10/16 type 200/N (7036470)**



TECHNICAL SPECIFICATIONS

Colour	black
Type	200/N
Material	cast iron GG 25
Surface treatment	powder coated
Operation	handwheel
Colour lever	black
Handle material	cast iron
Material valve	cast iron
Material spindle	stainless steel
Seat material	brass
Material housing	cast iron GG 25
Material seal	metal
Connection	DIN flange
Max. temperature	100 °C
Flange according to DIN	DIN 2501/PN10
Pressure	10 bar
Size	DN50

Flange PN10/16

PCD 125 mm

Holes 4

DIMENSIONS

Construction length din 3352/2c/f4

Ct-1 242 mm

L 150 mm

L 150 mm

PCD 125 mm

R 160 mm

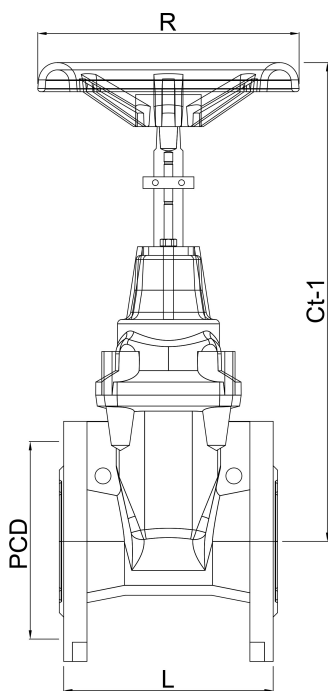

PRODUCT INFORMATION

Metal seated cast iron gate valve, non rising stem.

Last modified date: 24/02/2026

Bosta UK Ltd.
Reflection House
Olding Road
Bury St. Edmunds
Suffolk
IP33 3TA
T +44 (0) 1284 716580
E enquiries@bosta.co.uk
<http://www.bosta.com>