

Profec 3-piece ball valve stainless steel 316 1 1/2" female thread 69bar (0090957)



TECHNICAL SPECIFICATIONS

Material stainless steel 316

Operation lever

Colour lever blue

Handle material stainless steel

Material housing stainless steel 316

Material seal PTFE

Connection female thread

Temperature range -10°C - 150°C

Pressure 69 bar

Size 1 1/2"

DIMENSIONS

Ct-1 83 mm

F-1 22.6 mm

F-2 22.6 mm

Lb 102 mm

R 145 mm

ØDf 38 mm

ØDi-1 1 1/2 "

ØDi-2 1 1/2 "

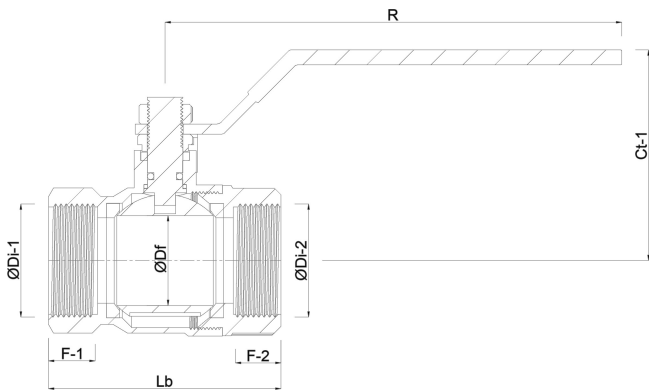

PRODUCT INFORMATION

Full flow.

Last modified date: 20/02/2026

Bosta UK Ltd.
Reflection House
Olding Road
Bury St. Edmunds
Suffolk
IP33 3TA
T +44 (0) 1284 716580
E enquiries@bosta.co.uk
<http://www.bosta.com>