

# Grundfos Multi-stage centrifugal pump stainless steel 1 1/4" 2,5A 400VAC type CRI 1-17 A CA I V HQQV (7039664)



GRUNDFOS 

# TECHNICAL SPECIFICATIONS

Material stainless steel

Shaft stainless steel 316

Pump body stainless steel 316

Material impeller 1 stainless steel 304

Voltage 400VAC

Temperature range -20°C - 90°C

Maximum ambient temperature 40 °C

Minimum ambient temperature 0 °C

Type CRI 1-17 A CA I V HQQV

Output Power 1.5 HP

MWC 105 m

Size 1 1/4"

Power 1.1 kW

Impellers 17

Ampere 2,5 A

Max flow rate 2.4 m<sup>3</sup>/h

Suction 1 1/4 "

Efficiency 82,7 %

Motor RPM 2770

## DIMENSIONS

Cb-1 50 mm

Cb-2 50 mm

H-1 766 mm

L 162 mm

W-1 210 mm

ØDi-1 35 mm

ØDi-2 35 mm

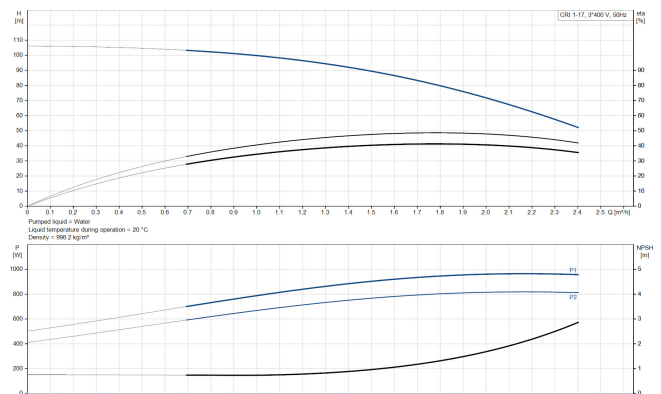
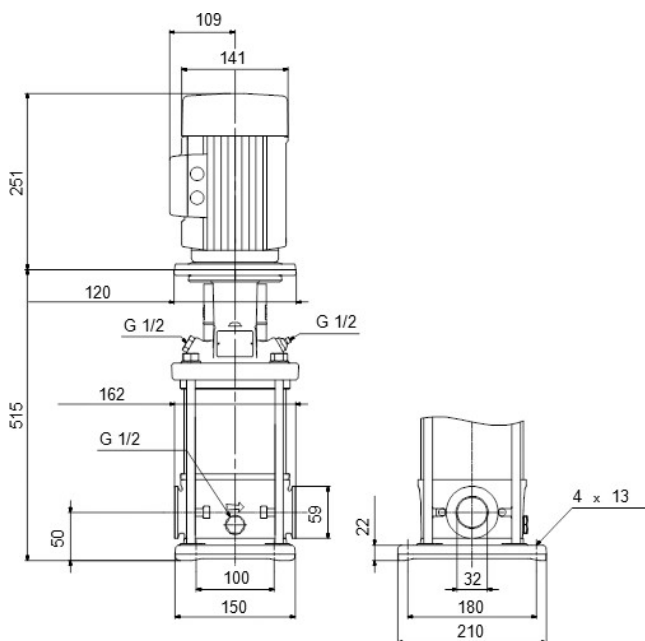

# PRODUCT INFORMATION

Grundfos CRI pumps are vertical, non-self-priming, multistage, in-line, centrifugal pumps for installation in pipe systems and mounting on a foundation, suitable for industrial applications. This design provides a more compact pump design and pipework. CR pumps are designed for a variety of applications ranging from the pumping of potable water to the pumping of chemicals. The pumps are therefore suitable for a wide range of pumping systems where the performance and material of the pump meet specific demands.

**Last modified date: 09/05/2026**

Bosta UK Ltd.  
Reflection House  
Olding Road  
Bury St. Edmunds  
Suffolk  
IP33 3TA  
T +44 (0) 1284 716580  
E [enquiries@bosta.co.uk](mailto:enquiries@bosta.co.uk)  
<http://www.bosta.com>